

PVC Coat Rack

a FORMUFIT PVC Plan

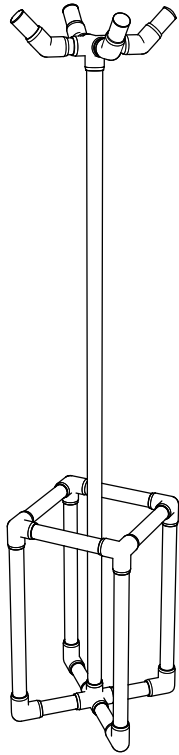



Important information.
Read carefully.
Keep this information for further
reference.

WARNING

Serious or fatal injuries can occur from using power tools when cutting PVC pipe. Be sure to read and understand the instructions that came with your power tools before using them.

PVC cement is a noxious chemical that should be used in a well ventilated area. If you become dizzy, light-headed or disoriented, move to fresh air.

Legal

DISCLAIMER: The information provided within this manual is for informational purposes only. FORMUFIT accepts no responsibility, and is excluded from all liability for damage and/or loss which may be suffered by any other party as a result of using or in connection with such use or loss of use of this information, including but not limited to loss of profit, loss of opportunity, loss of business, indirect damages, incidental damages, special or consequential loss, injury or loss of life.

Additional Information

For additional information on how to cut, prepare and assemble PVC, please review our FORMUFIT PVC Field Manuals available at:

<http://www.formufit.com/guides>

To order fittings, connectors, pipe or accessories for this project, visit FORMUFIT online at:

<http://www.formufit.com>

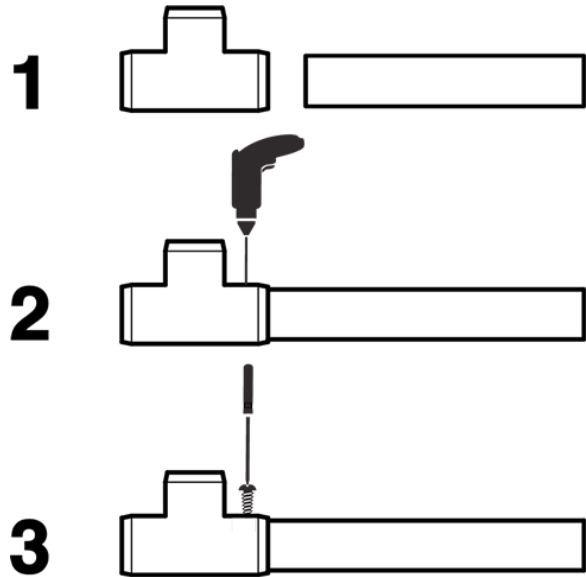
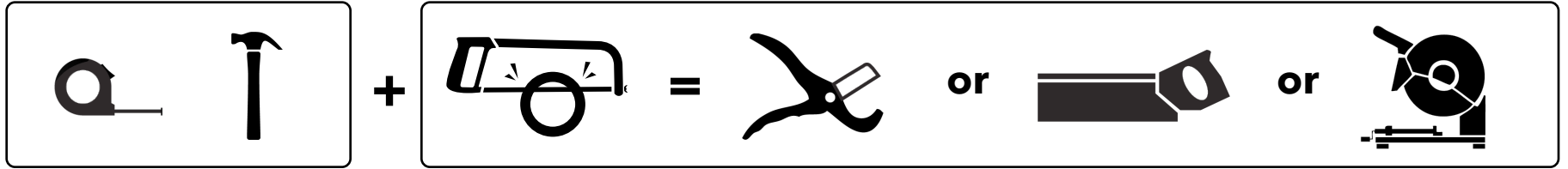

Tools



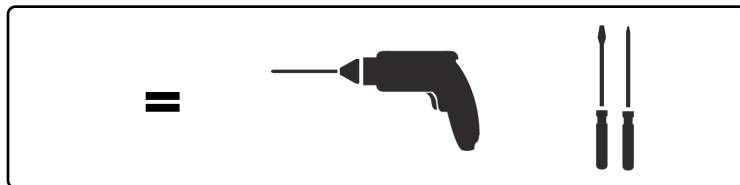
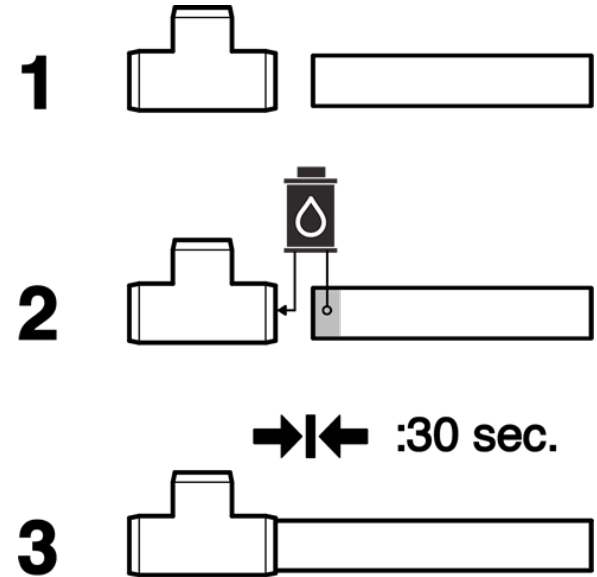

or

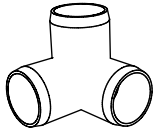

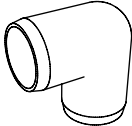
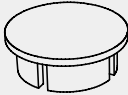
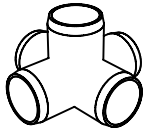
Parts

Quantity	Image	Description	Part Number
4x		1" 3-Way Elbow	F0013WE
4x		1" 45-Degree Elbow	F00145E
4x		1" 90-Degree Elbow	F00190E
4x		1" Internal Dome Cap	F001IDC
2x		1" 5-Way Cross	F0015WC

Pipe

 = 1" (1.315" OD)  = 19 ft.

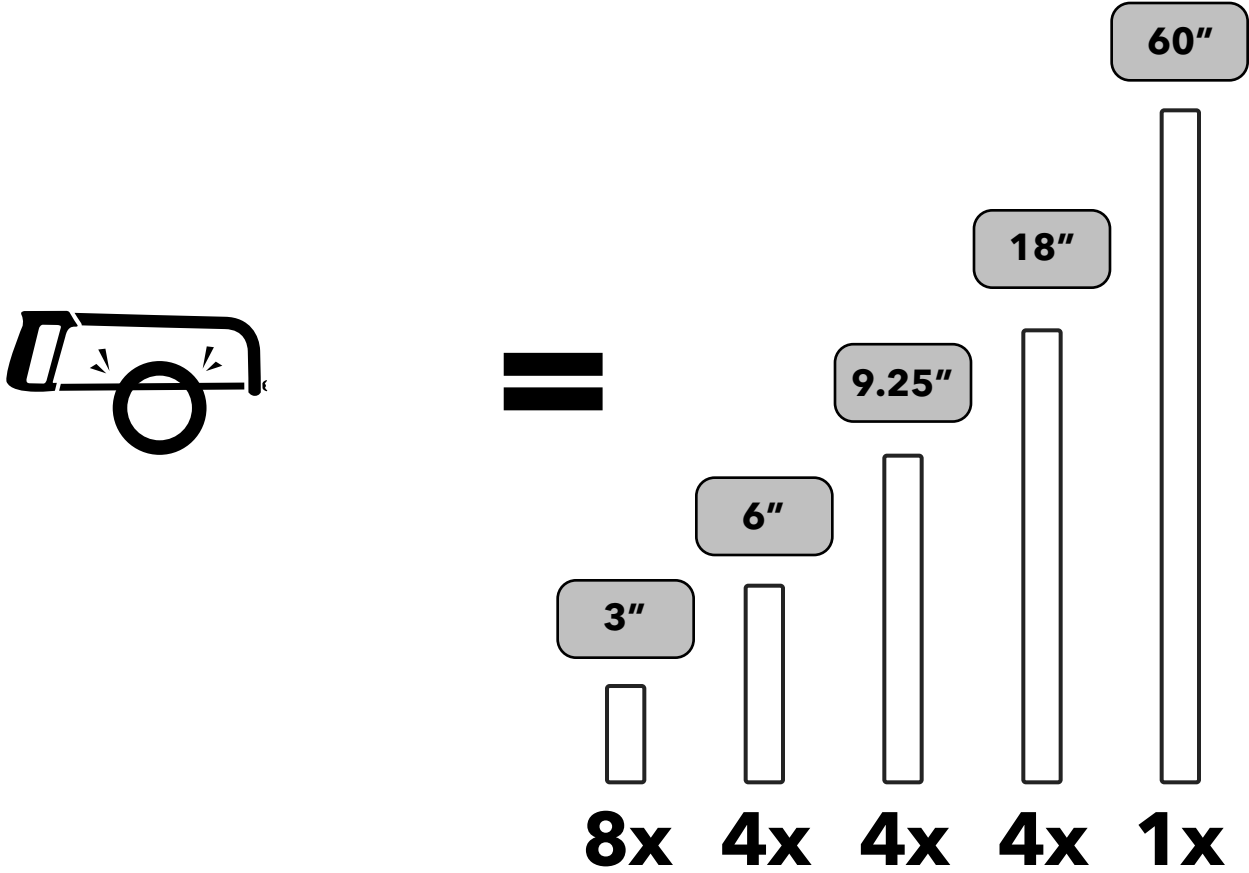

6

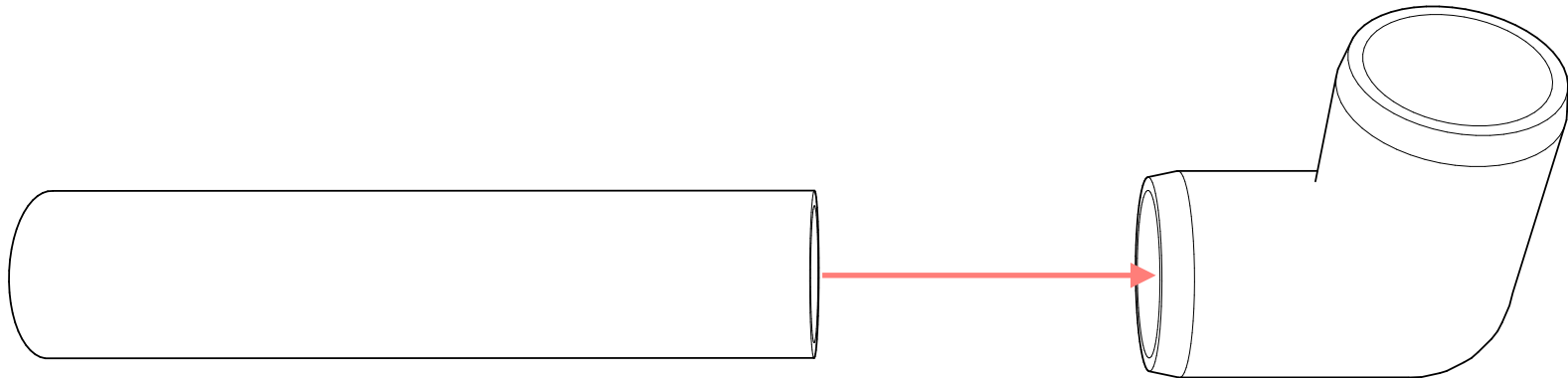
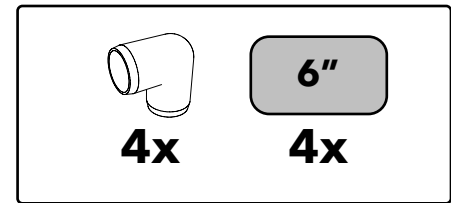

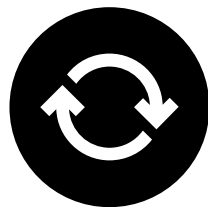
 = 4x

7

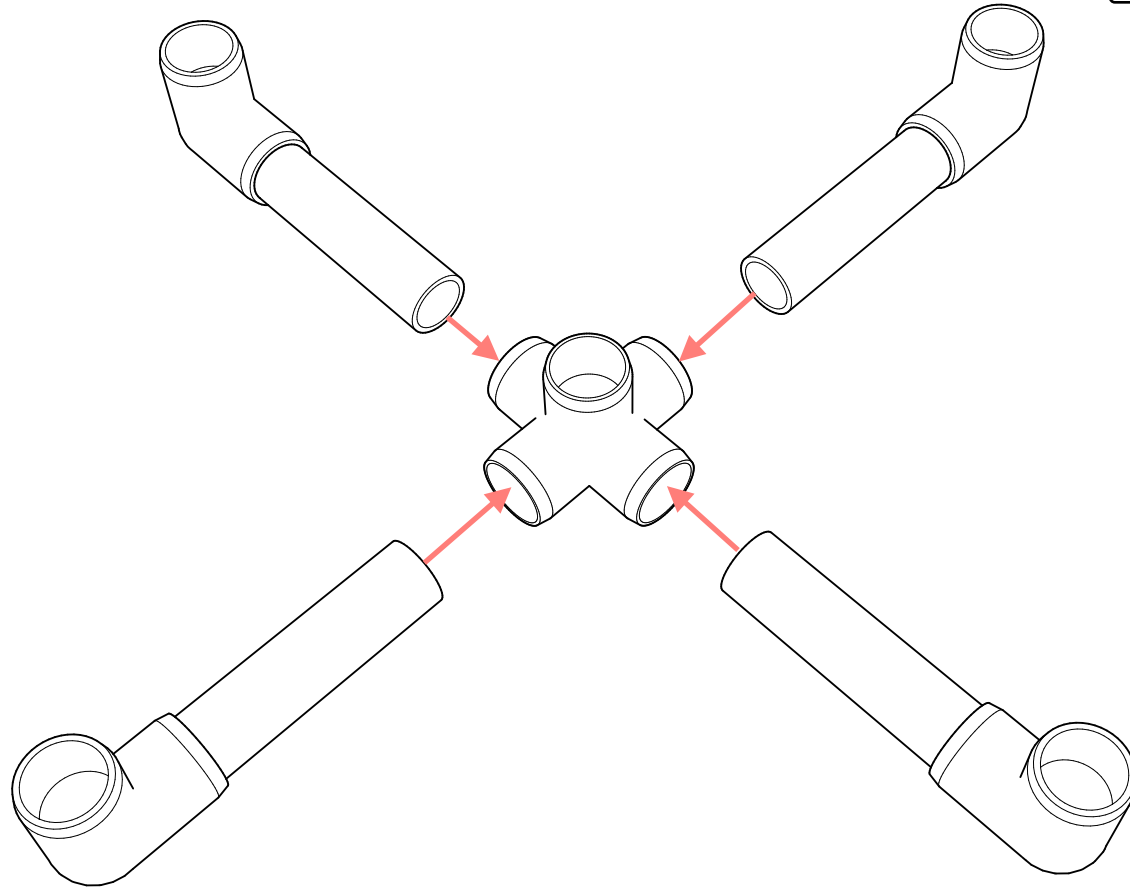
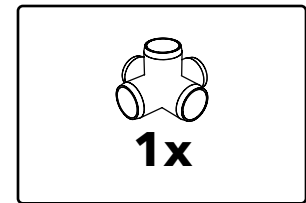

8

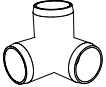
	9.25"
4x	4x

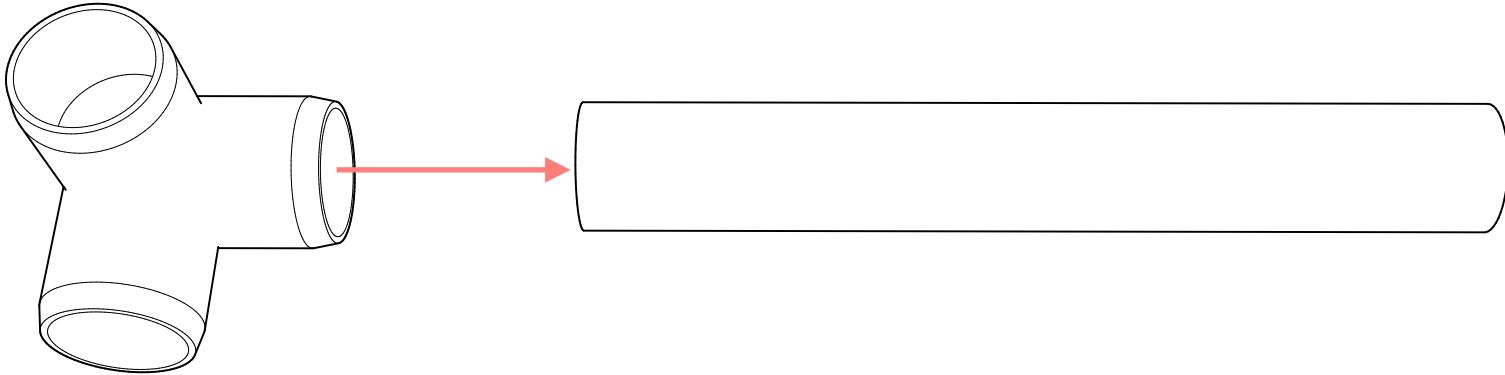

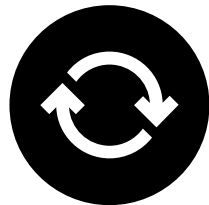
 = **4x**

8

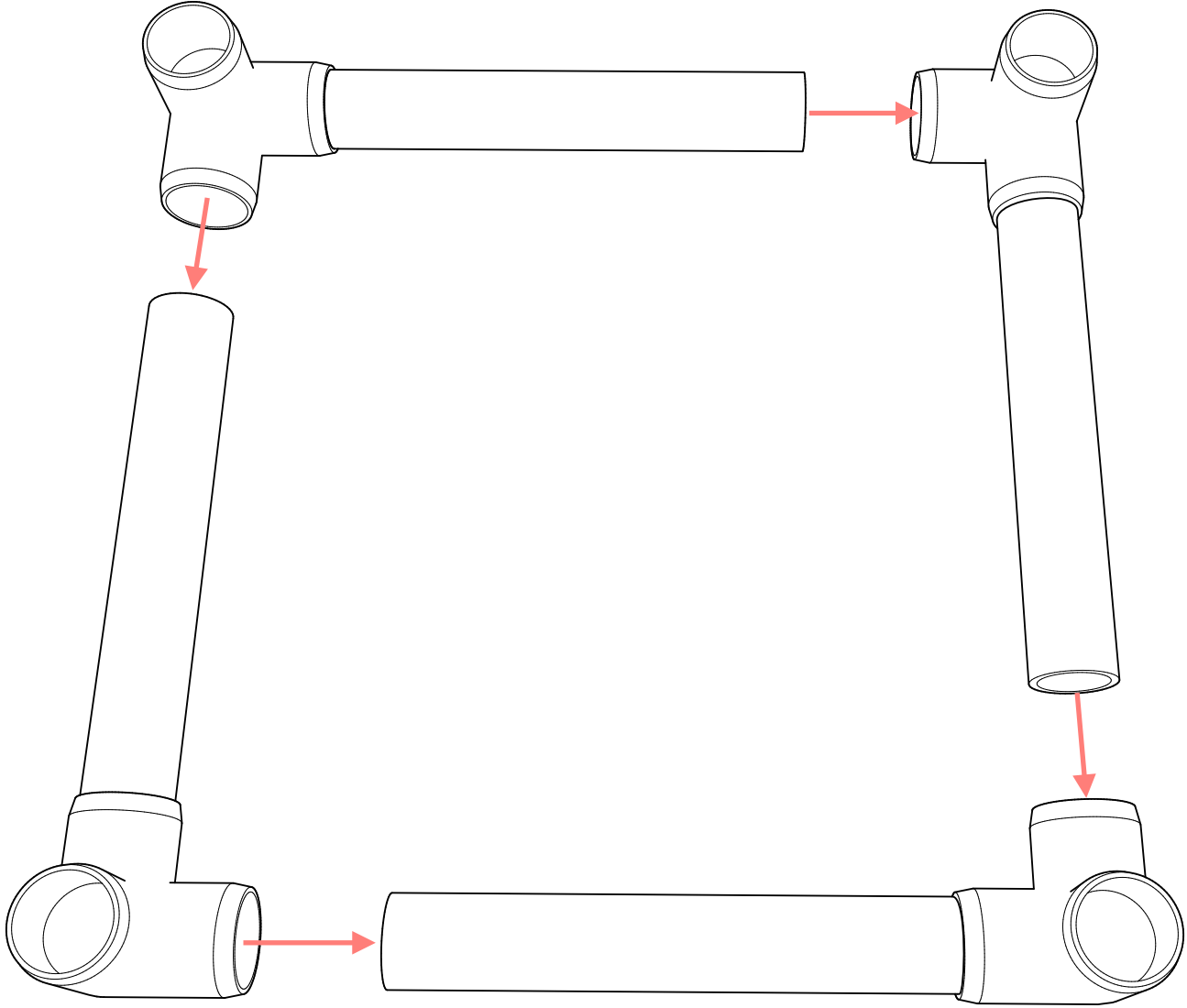

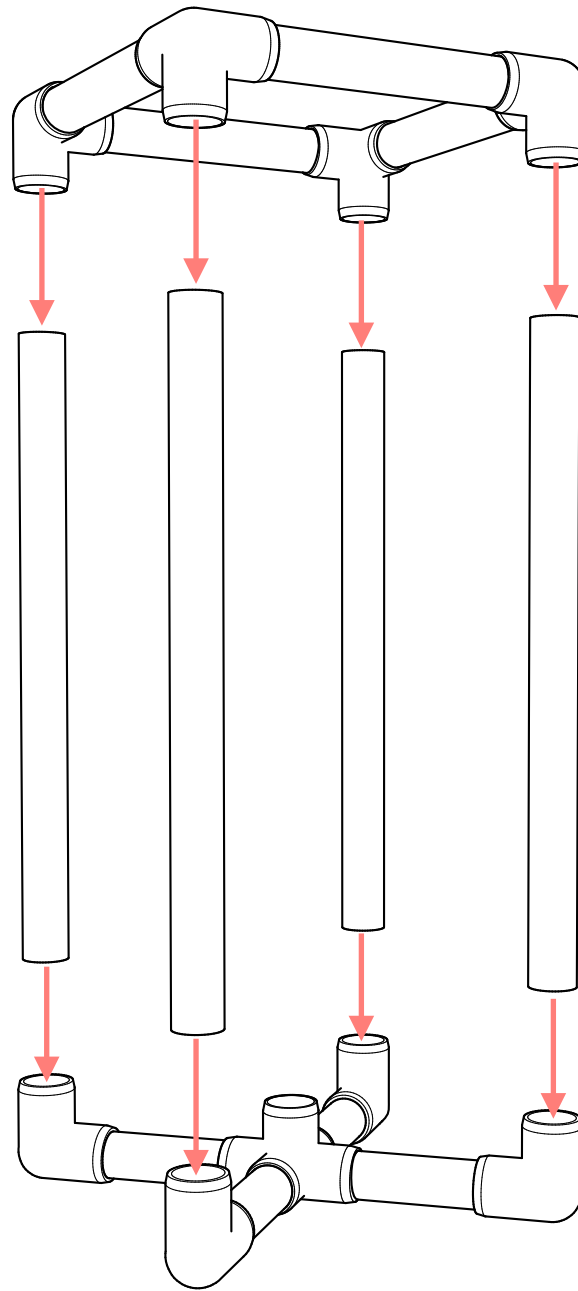

7

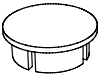

18"
4x

8

	
4x	4x

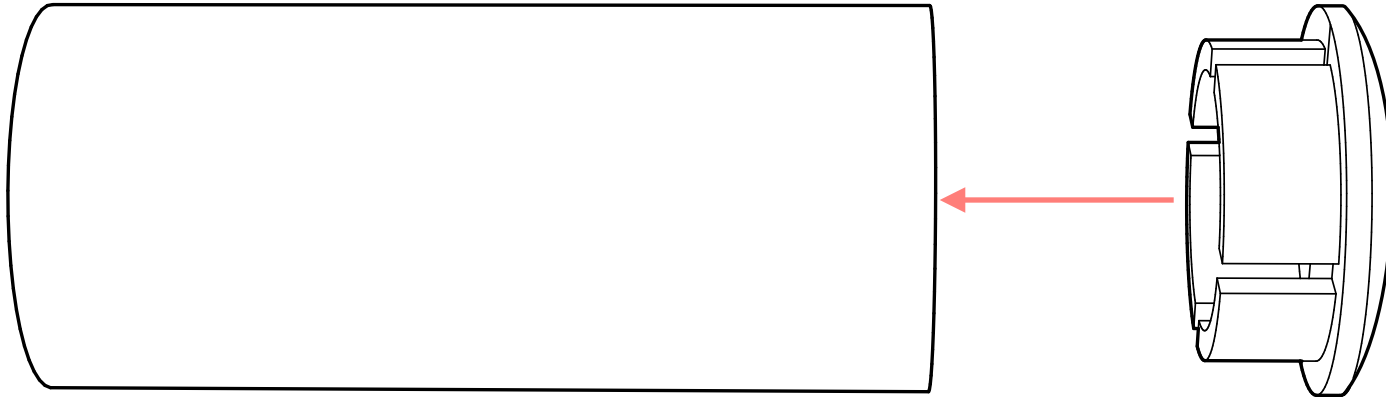

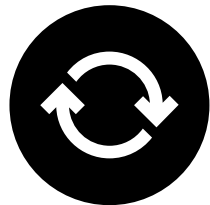
 = **4x**

8

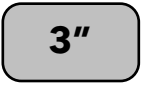
	
4x	4x

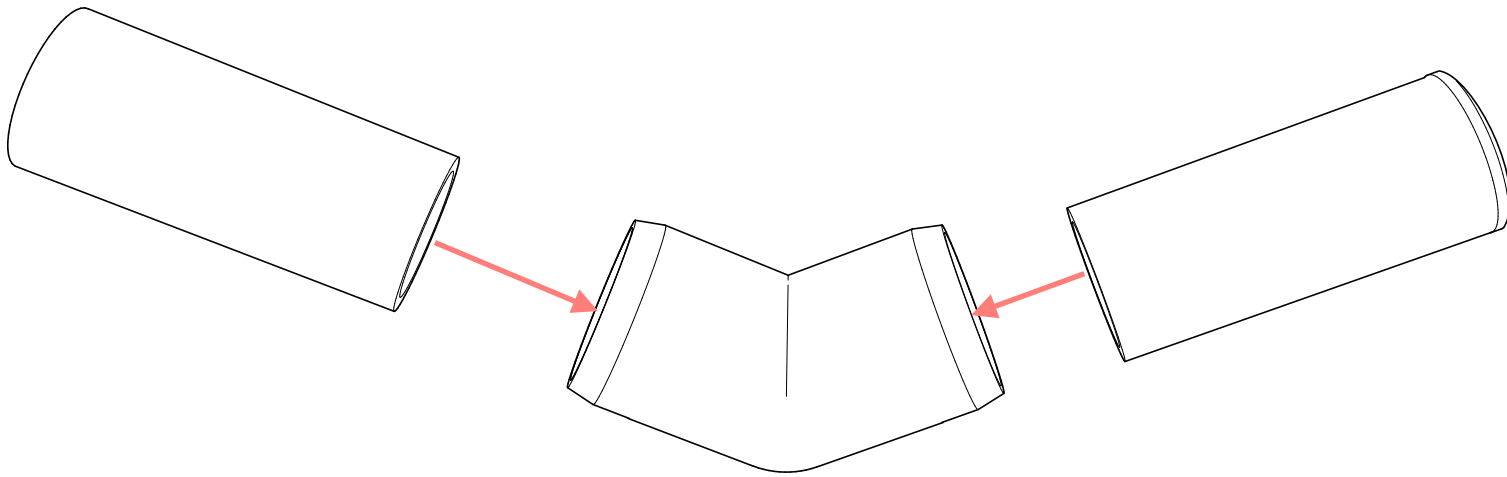

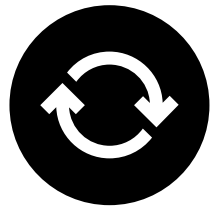
 = **4x**

8

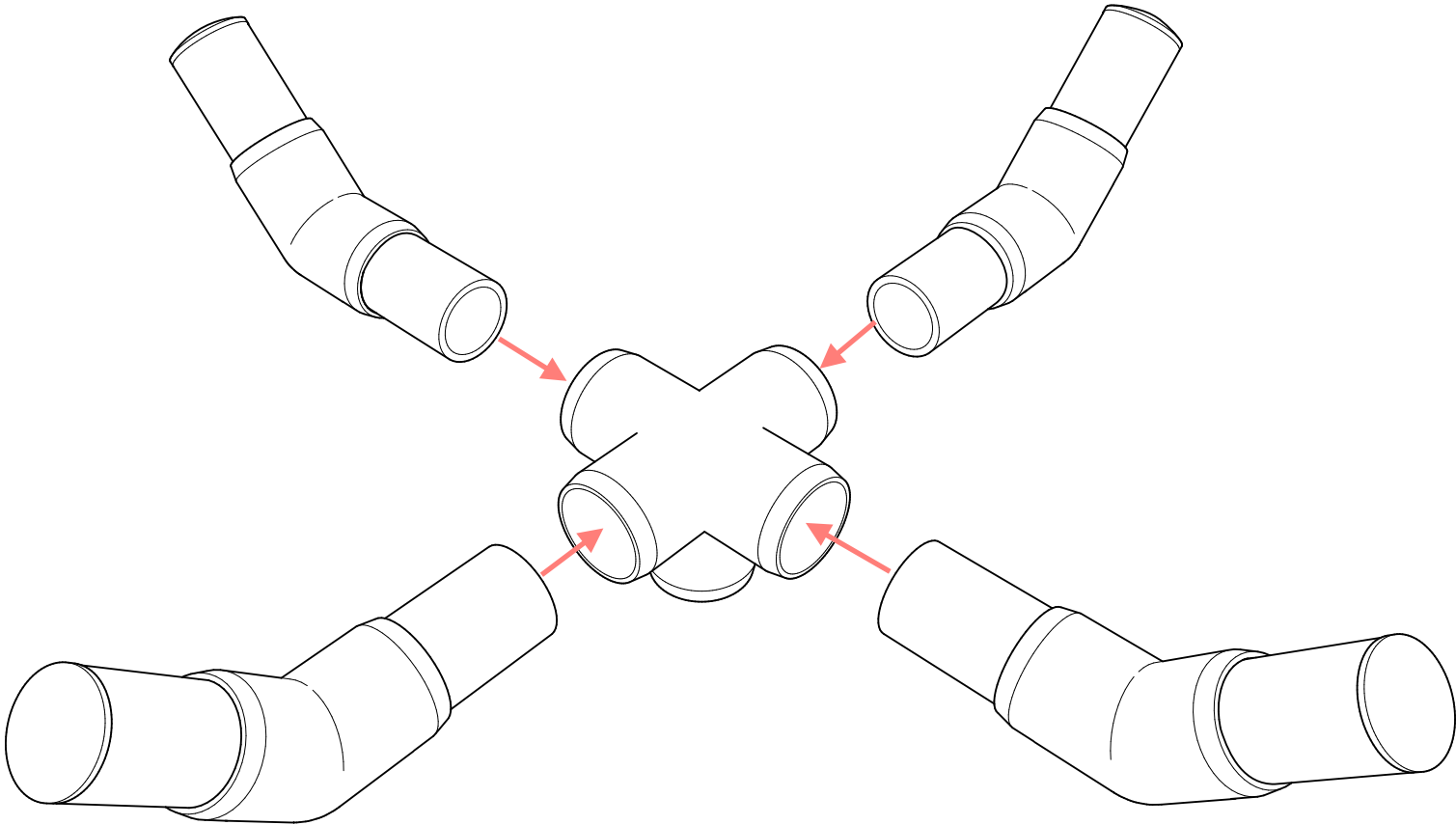
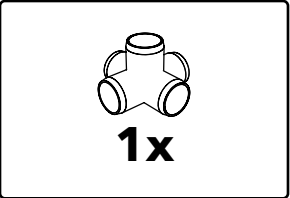

8

60"
1x

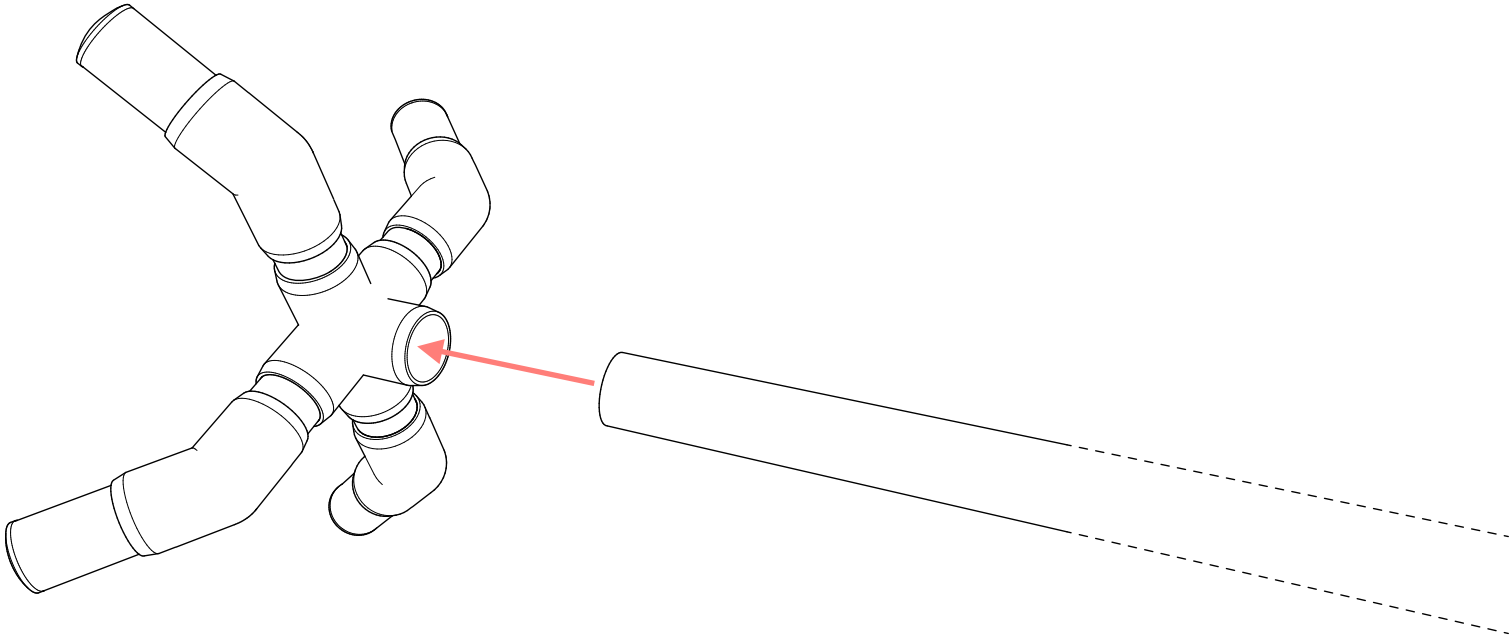

8

