

1-1/4" PVC Table Cap

SPECIFICATIONS

Product SKU: F114ECT

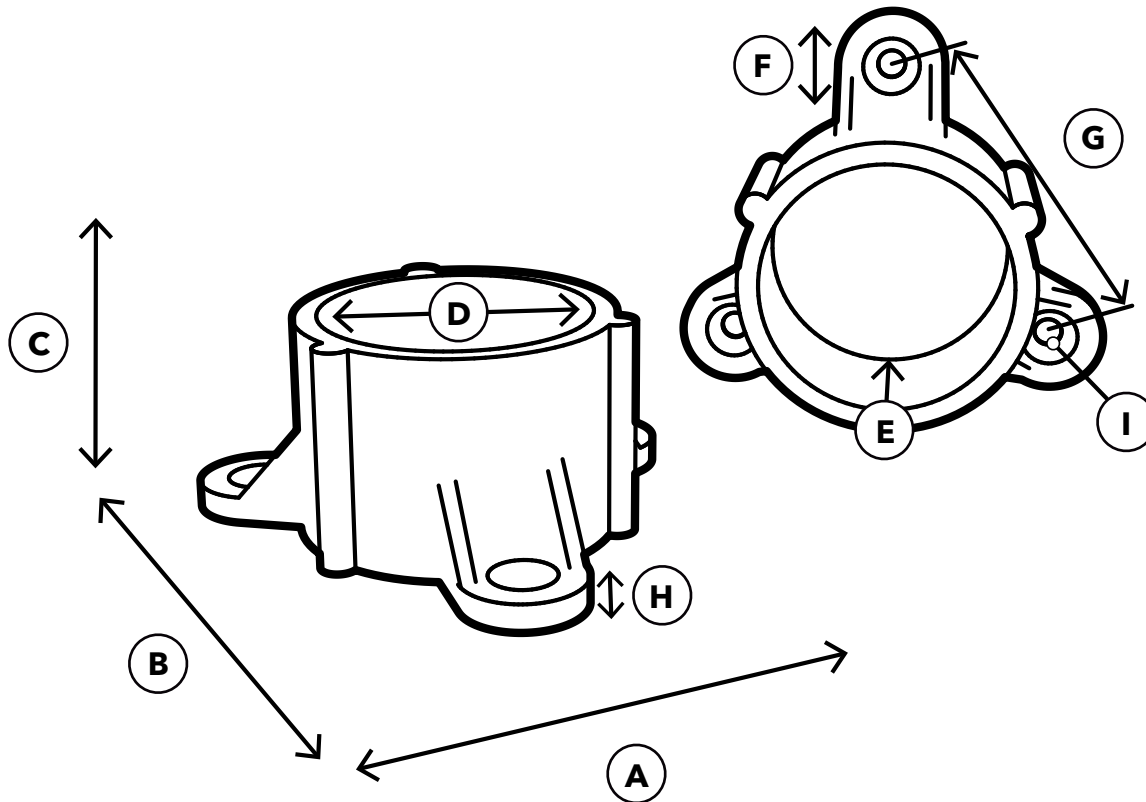

ID	Description	Dimension
A	Overall Width	3.117 in.
B	Overall Depth	2.830 in.
C	Overall Height	1.339 in.
D	Inside Diameter	1.660 in.
E	Insertion Depth	1.239 in.
F	Tab Length	0.756 in.
G	Hole Distance	2.397 in.
H	Tab Height	0.181 in.
I	Screw Hole*	0.190 in.
	Weight	0.075 lb.

*Recommended screw size is number ten (#10)

NOTICE: All information within this Technical Specifications document is accurate at the time of document date. Product specifications and/or appearance may change.

